

TARIFA PRECIOS

Fernando Reyes, S.L.

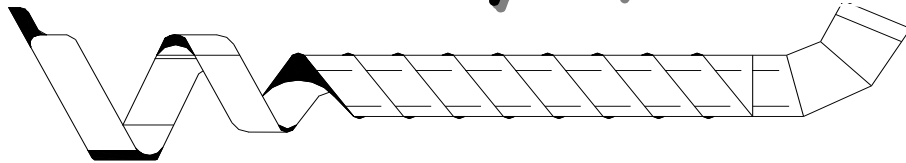

TUBERIAS Y ACCESORIOS PARA CONDUCTOS DE VENTILACION

**POLIGONO INDUSTRIAL NAVISA
CALLE LOS PALOS, N° 39
41006-SEVILLA
TELF. 954643569
freysl@freysl.com**

Fernando Reyes, S.L.

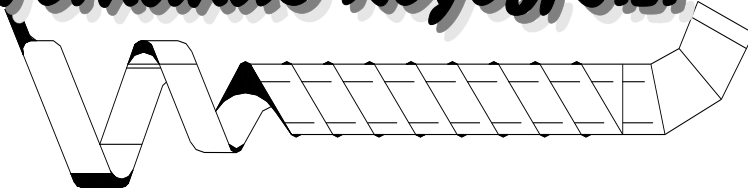

POLIGONO INDUSTRIAL NAVISA

C/ LOS PALOS, Nº 39

41006 SEVILLA

TELF. 954643569

freyesl@freyesl.com

TUBERIAS Y ACCESORIOS PARA CONDUCTOS DE VENTILACIÓN

TUBO HELICOIDAL

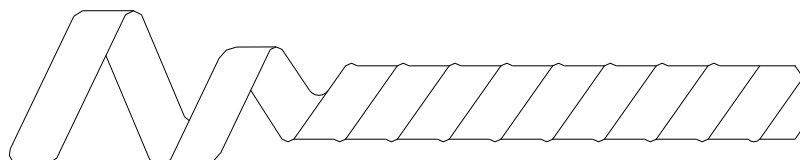

D (mm)	0.5 mm de espesor (Euros / m)	0.6 mm de espesor (Euros / m)	0.8 mm de espesor (Euros / m)
100	4,10		
125	5,16		
150	6,15		
200	8,26		
250	11,60		
300	14,06	15,47	
350	16,86	18,27	
400	18,27	22,37	
450	20,55	25,38	
500	23,70	29,25	
550		32,42	
600		35,03	42,17
650		40,68	45,67
700		44,74	49,19
750			55,16
800			58,84
900			73,55
1000			81,72

Fernando Reyes, S.L.

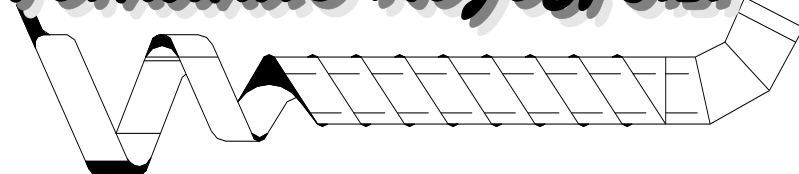

POLIGONO INDUSTRIAL NAVISA

C/ LOS PALOS, N° 39

41006 SEVILLA

TELF. 954643569

freyesl@freyesl.com

TUBERIAS Y ACCESORIAS PARA CONDUCTOS DE VENTILACION

CODO 90°

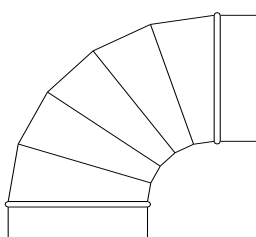

CODO 45°

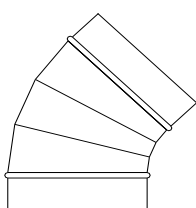

CODO 60°

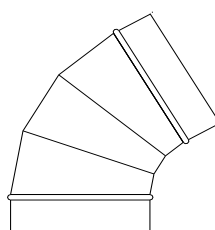

CODO 120°

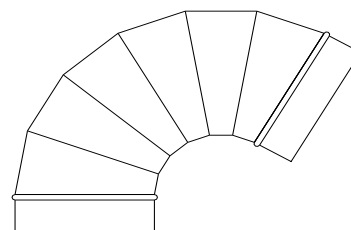

D	EUROS	D	EUROS	D	EUROS	D	EUROS
100	9,62	100	8,14	100	10,19	100	22,46
125	11,58	125	8,75	125	11,86	125	25,84
150	13,61	150	10,12	150	13,54	150	30,83
200	18,85	200	13,36	200	17,19	200	40,17
250	25,42	250	18,02	250	20,81	250	55,77
300	33,75	300	25,03	300	29,00	300	74,00
350	40,20	350	30,82	350	36,13	350	84,52
400	49,97	400	33,00	400	41,11	400	107,35
450	57,70	450	38,32	450	46,18	450	124,69
500	67,31	500	43,09	500	50,66	500	135,65
550	76,57	550	49,92	550	56,11	550	149,16
600	81,98	600	53,37	600	59,14	600	156,87
650	90,45	650	57,48	650	66,86	650	169,56
700	108,72	700	70,05	700	76,61	700	180,89
750	136,20	750	82,82	750	88,39	750	192,35
800	161,90	800	95,23	800	103,35	800	201,42
900	214,04	900	125,02	900	133,92	900	223,55
1000	256,58	1000	172,18	1000	188,38	1000	248,54

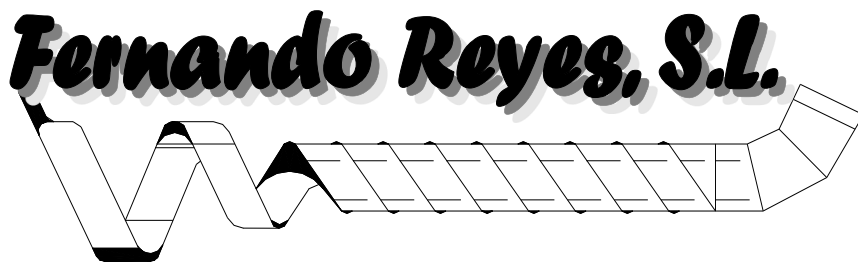

POLIGONO INDUSTRIAL NAVISA
 C/ LOS PALOS, Nº 39
 41006-SEVILLA
 TELF. 954643569
 freyesl@freyesl.com

TUBERIAS Y ACCESORIOS PARA CONDUCTOS DE VENTILACIÓN

**CAPERUZAS
 SIMPLES**

**CAPERUZAS
 DEFLECTORAS**

**CAPERUZAS
 AUTOASPIRANTES**

**CAPERUZAS
 GIRATORIAS**

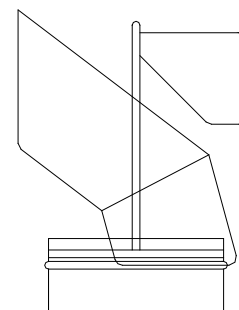
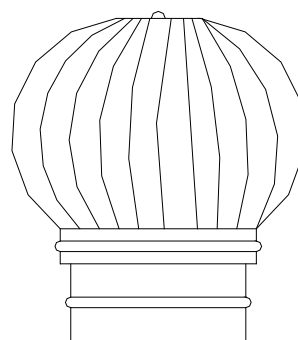
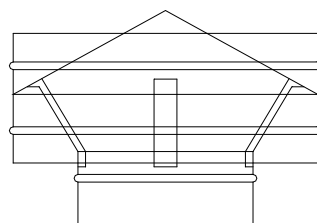
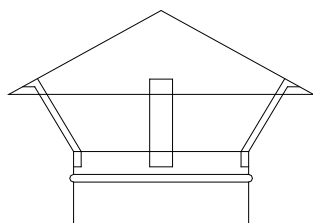

D	EUROS	D	EUROS	D	EUROS	D	EUROS
100	14,80	100	18,35	100	44,90	100	38,65
125	16,40	125	19,72	125	47,20	125	43,24
150	17,52	150	22,59	150	49,80	150	55,04
200	21,23	200	26,21	200	52,90	200	59,71
250	25,49	250	32,20	250	57,14	250	68,00
300	29,64	300	37,19	300	62,20	300	74,59
350	34,06	350	42,03	350	81,00	350	
400	39,04	400	49,60	400		400	
450	47,72	450	58,97	450		450	
500	54,97	500	66,20	500		500	
550	61,31	550	73,86	550		550	
600	72,13	600	88,82	600		600	
650	78,12	650	99,36	650		650	
700	84,17	700	112,44	700		700	

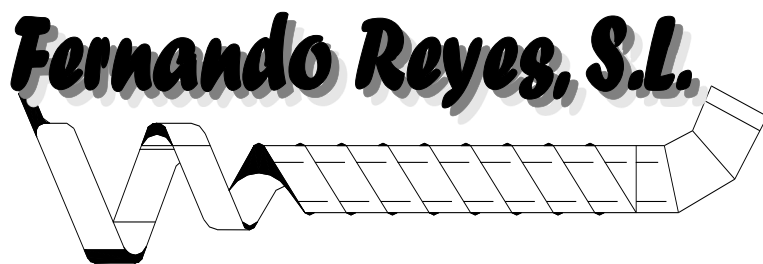

POLIGONO INDUSTRIAL NAVISA

C/ LOS PALOS, Nº 39

41006-SEVILLA

TELF. 954643569

freyesl@freyesl.com

TUBERIAS Y ACCESORIOS PARA CONDUCTOS DE VENTILACIÓN

BIFURCACIÓN

REGISTRO REGULABLE

BOTAGUAS

PICO FLAUTA

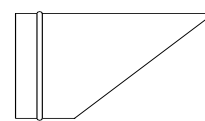
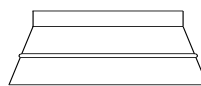
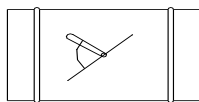
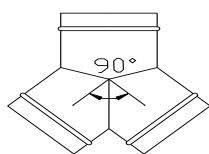

D	EUROS	D	EUROS	D	EUROS	D	EUROS
100	33,60	100	27,10	100	16,46	100	28,84
125	34,85	125	27,40	125	17,55	125	30,50
150	37,69	150	29,95	150	18,70	150	34,28
200	43,11	200	33,11	200	22,98	200	36,87
250	51,16	250	38,43	250	28,73	250	42,57
300	61,05	300	47,73	300	33,84	300	47,76
350	74,95	350	53,95	350	41,46	350	50,78
400	90,52	400	65,62	400	47,52	400	58,86
450	103,20	450	66,81	450	56,18	450	62,16
500	115,51	500	75,15	500	61,20	500	64,43
550	121,31	550	86,84	550	65,80	550	66,45
600	155,23	600	95,48	600	79,06	600	68,54
650	165,30	650	99,58	650	86,17	650	74,88
700	187,95	700	114,98	700	101,60	700	81,85

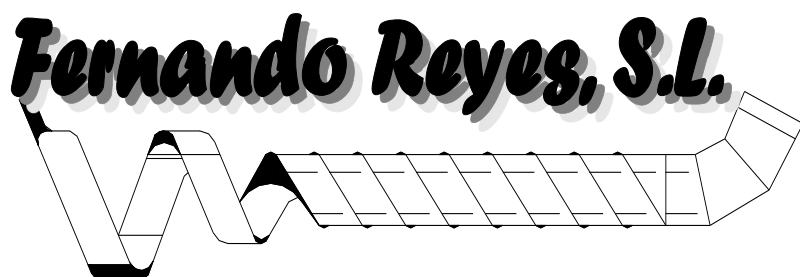

POLIGONO INDUSTRIAL NAVISA

C/ LOS PALOS, Nº 39

41006-SEVILLA

TELF. 954643569

freyesl@freyesl.com

TUBERIAS Y ACCESORIOS PARA CONDUCTOS DE VENTILACIÓN

MANGUITO DE UNION

TAPA

MANGUITO CON PESTAÑA

TAPA CON MALLA

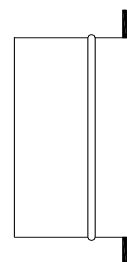
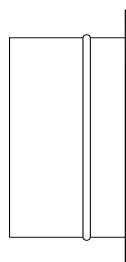
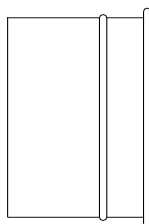
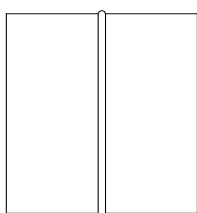

D	EUROS	D	EUROS	D	EUROS	D	EUROS
100	2,21	100	7,66	100	6,08	100	18,92
125	2,27	125	7,66	125	6,14	125	18,92
150	2,34	150	7,66	150	6,20	150	18,92
200	2,90	200	8,55	200	8,20	200	21,27
250	3,67	250	9,11	250	10,21	250	22,45
300	4,62	300	10,32	300	11,32	300	25,44
350	4,99	350	13,35	350	12,92	350	31,76
400	5,61	400	14,92	400	13,52	400	33,06
450	6,70	450	18,67	450	15,94	450	36,97
500	7,62	500	19,99	500	19,10	500	43,53
550	8,55	550	20,78	550	20,29		
600	9,68	600	24,22	600	23,53		
650	11,26	650	27,42	650	26,78		
700	12,40	700	31,94	700	27,88		
750	15,31	750	34,65	750	32,27		
800	16,55	800	35,84	800	35,55		
900	19,75	900	41,58	900	43,20		
1000	23,35	1000	50,41	1000	56,98		

Fernando Reyes, S.L.

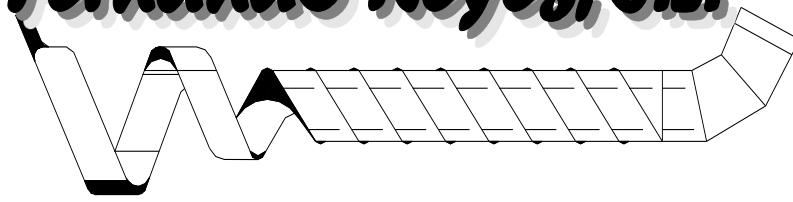

POLIGONO INDUSTRIAL NAVISA

C/ LOS PALOS, Nº 39

41006-SEVILLA

TELF. 954643569

freyesl@freyesl.com

TUBERIAS Y ACCESORIOS PARA CONDUCTOS DE VENTILACIÓN

TE DE 45°

$d < D$

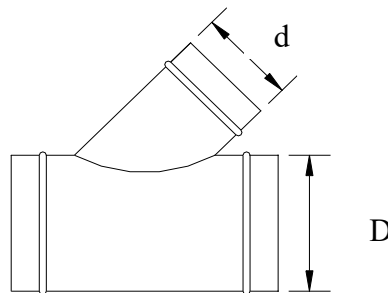

D / d	100	125	150	200	250	300	350	400	450	500	550	600	650	700	750	800	900	1000
100	16,80																	
125	18,46	18,46																
150	19,17	19,17	19,17															
200	20,71	20,71	20,71	22,78														
250		25,41	25,41	33,05	33,05													
300		28,00	28,00	45,12	45,12	45,12												
350			33,59	47,42	47,42	47,42	51,64											
400			34,47	50,74	50,74	50,74	65,39	65,39										
450			35,04	55,44	55,44	55,44	83,68	83,68	83,68									
500			43,33	64,58	64,58	64,58	91,85	91,85	91,85	91,85								
550				67,57	67,57	67,57	95,50	95,50	95,50	95,50	112,08							
600					69,40	69,40	111,92	111,92	111,92	111,92	137,17	137,17						
650					72,56	72,56	115,32	115,32	115,32	115,32	151,74	151,74	151,74					
700						76,56	120,44	120,44	120,44	120,44	160,80	160,80	160,80	160,80				
750							122,70	123,20	123,20	123,20	162,21	165,11	165,11	173,20	173,20			
800								124,85	124,85	124,85	164,09	170,24	170,24	184,40	190,32	200,73		
900								126,45	126,45	145,23	165,46	172,90	182,38	184,52	227,17	259,84	269,52	
1000									146,25	151,16	170,24	185,12	194,59	241,92	258,68	269,08	280,36	343,22

Fernando Reyes, S.L.

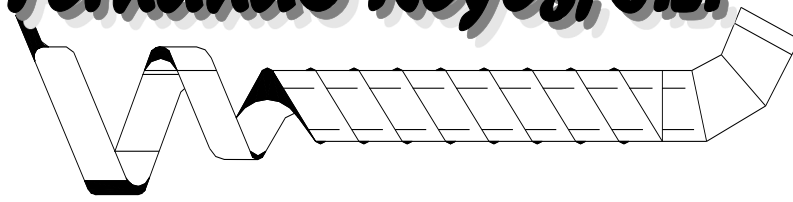

POLIGONO INDUSTRIAL NAVISA

C/ LOS PALOS, Nº 39

41006-SEVILLA

TELF. 954643569

freyesl@freyesl.com

TUBERIAS Y ACCESORIOS PARA CONDUCTOS DE VENTILACIÓN

TE DE 90°

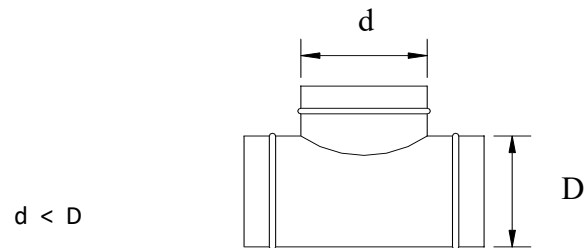

D / d	100	125	150	200	250	300	350	400	450	500	550	600	650	700	750	800	900	1000
100	13,57																	
125	13,57	13,57																
150	13,57	13,57	13,57															
200	16,50	16,50	16,50	17,72														
250	21,70	21,70	21,70	23,80	24,98													
300	25,56	25,56	25,56	29,19	30,07	30,64												
350	32,90	32,90	32,90	36,15	36,15	37,24	41,80											
400		36,53	36,53	41,60	41,60	43,68	47,25	47,25										
450			48,78	55,06	55,06	55,06	59,75	59,75	61,54									
500			57,25	60,88	60,88	60,88	64,02	64,02	64,02	67,22								
550				61,41	61,41	61,41	64,21	64,21	64,21	66,14	68,68							
600					64,21	64,21	71,54	71,54	71,54	73,70	82,42	84,02						
650					65,27	65,27	73,51	73,51	73,51	77,18	90,22	94,74	94,74					
700						66,40	75,39	75,39	75,39	77,66	107,60	107,60	107,60	107,60				
750							82,94	82,94	92,94	85,43	118,35	118,35	118,35	118,35				
800								90,35	110,15	109,32	127,21	144,50	154,10	172,32	178,80	187,58		
900								114,52	118,17	133,16	154,62	161,65	170,43	181,77	212,30	228,23	248,49	
1000									136,67	141,26	153,68	173,00	181,85	226,07	241,73	251,46	262,00	320,73

Fernando Reyes, S.L.

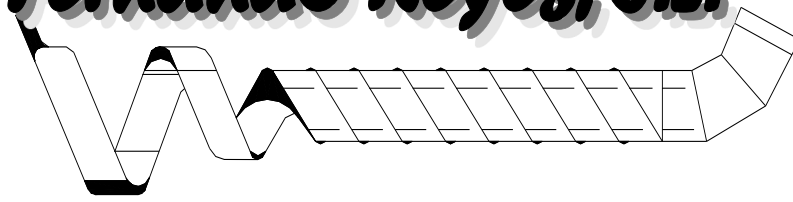

POLIGONO INDUSTRIAL NAVISA

C/ LOS PALOS, Nº 39

41006-SEVILLA

TELF. 954643569

freyesl@freyesl.com

TUBERIAS Y ACCESORIOS PARA CONDUCTOS DE VENTILACIÓN

REDUCCIONES

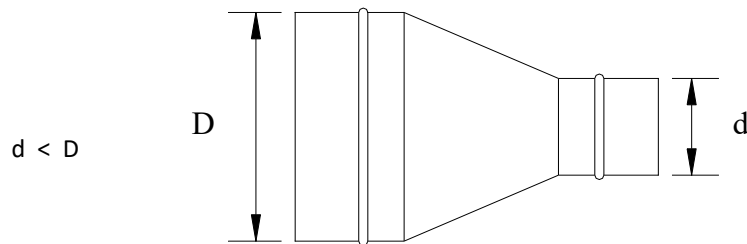

D / d	100	125	150	200	250	300	350	400	450	500	550	600	650	700	750	800	900	1000
100																		
125	13,27																	
150	13,27	13,27																
200	14,37	14,37	14,37															
250	18,66	18,66	18,66	17,54														
300	22,90	22,90	22,90	21,78	21,78													
350	27,02	27,02	27,02	25,23	25,23	25,23												
400		32,59	32,59	30,68	30,68	30,38	29,71											
450			39,64	38,60	38,60	38,60	37,08	37,08										
500			40,01	38,96	38,96	38,96	37,44	37,44	37,44									
550				44,14	44,14	44,14	42,44	42,44	42,44	42,44								
600					51,90	51,90	50,04	50,04	50,04	50,04	48,91							
650						57,88	57,88	55,94	55,94	55,94	55,94	55,24	55,24					
700							63,71	61,84	61,84	61,84	61,84	60,47	60,47	60,47				
750								66,15	64,75	64,75	64,75	63,91	63,91	63,91	63,91			
800									71,76	70,92	70,92	70,92	69,10	69,10	69,10	69,10		
900										80,45	80,45	78,63	78,63	78,63	77,93	77,93	77,93	
1000											90,96	89,70	89,70	89,70	88,93	88,93	88,93	88,93

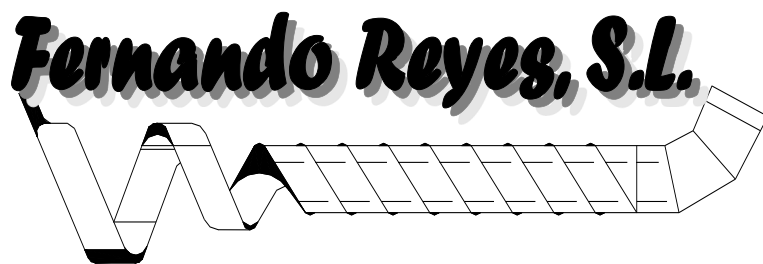

POLIGONO INDUSTRIAL NAVISA

C/ LOS PALOS, Nº 39

41006-SEVILLA

TELF. 954643569

freyesl@freyesl.com

TUBERIAS Y ACCESORIOS PARA CONDUCTOS DE VENTILACIÓN

BRIDAS

ABRAZADERAS

**ABRAZADERAS
ATORNILLADAS**

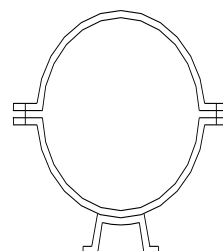
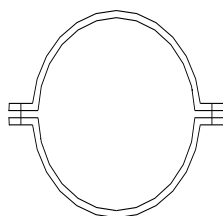
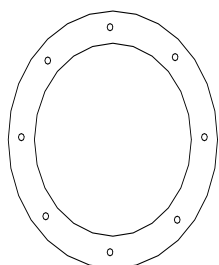

D	EUROS	D	EUROS	D	EUROS
100	16,49	100	3,70	100	4,48
125	16,49	125	3,81	125	4,63
150	16,49	150	4,73	150	5,73
200	17,52	200	5,30	200	6,43
250	18,35	250	6,70	250	8,12
300	21,94	300	7,13	300	8,66
350	24,70	350	9,14	350	10,16
400	26,11	400	9,23	400	10,23
450	28,40	450	10,21	450	11,13
500	30,32	500	11,33	500	12,34
550	33,14	550	12,53	550	13,66
600	36,13	600	14,00	600	15,26
650	40,03	650	15,61	650	17,01
700	43,91	700	17,22	700	18,77
750	66,28	750	18,84	750	
800	74,87	800	20,98	800	
900	92,87	900	22,04	900	
1000	123,15	1000	25,02	1000	

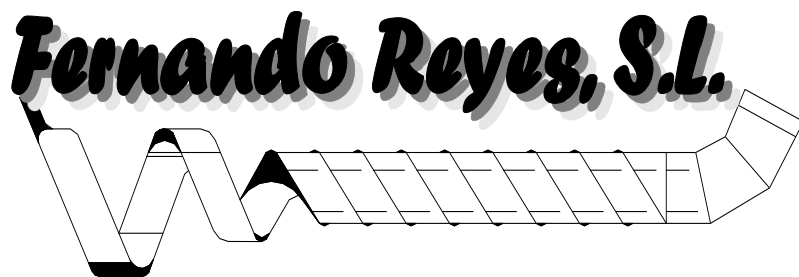

POLIGONO INDUSTRIAL NAVISA

C/ LOS PALOS, Nº 39

41006-SEVILLA

TELF. 954643569

freyesl@freyesl.com

TUBERIAS Y ACCESORIOS PARA CONDUCTOS DE VENTILACIÓN

TOLVAS

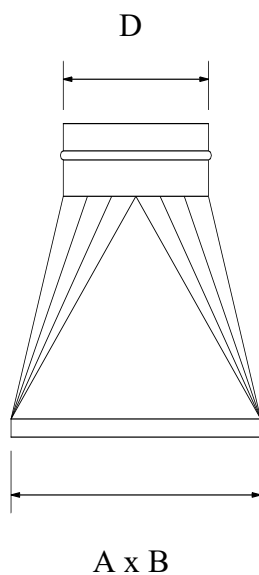

A + B + D	EUROS
500	41,16
600	41,16
700	45,74
800	47,10
900	50,49
1000	54,75
1100	58,54
1200	62,20
1300	67,21
1400	71,70
1500	76,38
1600	81,17
1700	86,07
1800	91,20
1900	96,04
2000	102,44
2100	114,29
2200	120,15
2300	126,49
2400	132,85
2600	145,55

Fernando Reyes, S.L.

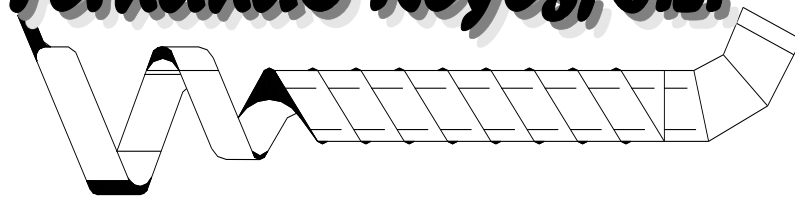

POLIGONO INDUSTRIAL NAVISA

C/ LOS PALOS, Nº 39

41006-SEVILLA

TELF. 954643569

TUBERIAS Y ACCESORIOS PARA CONDUCTOS DE VENTILACIÓN

TOLVAS EXCENTRICAS

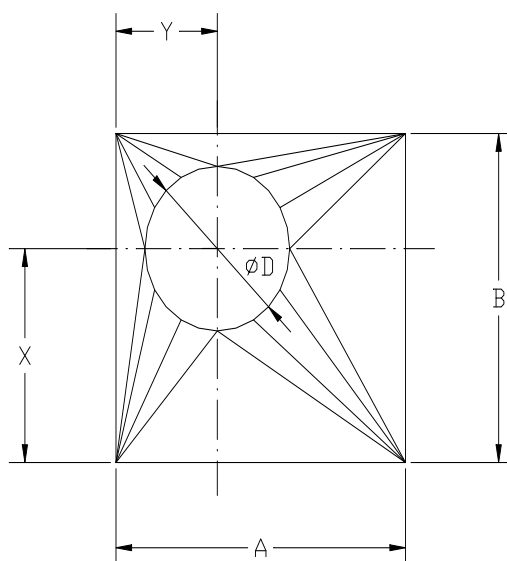

A + B + D	EUROS
500	51,82
600	51,82
700	57,57
800	59,30
900	63,58
1000	62,65
1100	68,92
1200	78,32
1300	84,61
1400	90,28
1500	96,16
1600	102,20
1700	108,36
1800	114,81
1900	120,91
2000	128,96
2100	145,30
2200	152,75
2300	160,83
2400	168,90
2600	185,04

Fernando Reyes, S.L.

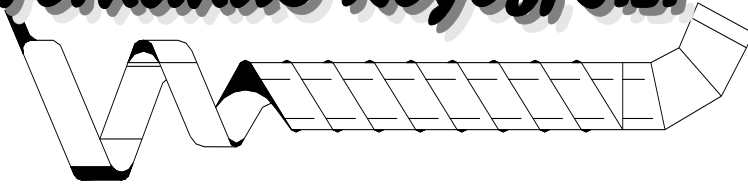

POLIGONO INDUSTRIAL NAVISA

C/ LOS PALOS, Nº 39

41006-SEVILLA

TELF. 954643569

freyesl@freyesl.com

TUBERIAS Y ACCESORIOS PARA CONDUCTOS DE VENTILACIÓN

TOLVA-CODO

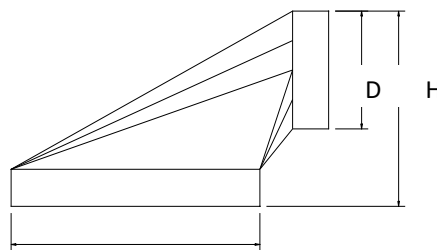

A x B

Modelo	Dimensión	D						
ventilador	(A x B)	150	200	250	300	350	400	450
7/7	230 x 230	40.65	40.65	40.65	40.65			
9/9	300 x 300		46.23	46.23	46.23	46.23		
10/10	330 x 330			48.73	48.73	48.73	48.73	
12/12	410 x 410			50.43	50.43	50.43	50.43	50.43
15/15	500 x 500			56.23	56.23	56.23	56.23	56.23
18/18	560 x 560				67.16	67.16	67.16	67.16

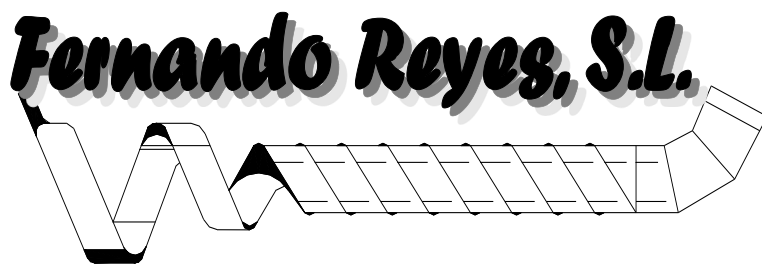

POLIGONO INDUSTRIAL NAVISA

C/ LOS PALOS, Nº 39

41006-SEVILLA

TELF. 954643569

freyesl@freyesl.com

TUBERIAS Y ACCESORIOS PARA CONDUCTOS DE VENTILACIÓN

VISERA

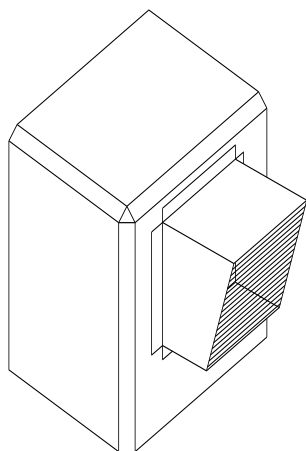

MODELO CAJA	DIMENSIONES	EUROS
Para tipo (7/7)	320 x 280	36.79
Para tipo (9/9)	320 x 280	36.79
Para tipo (10/10)	350 x 310	37.77
Para tipo (12/12)	410 x 370	40.26
Para tipo (15/15)	500 x 430	43.77
Para tipo (18/18)	560 x 510	49.37

Fernando Reyes, S.L.

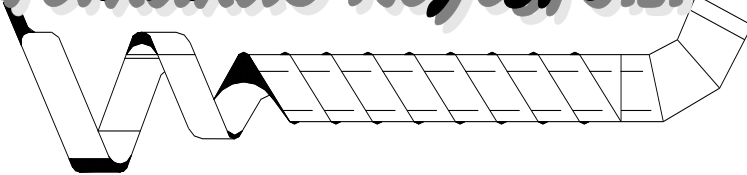

POLIGONO INDUSTRIAL NAVISA

C/ LOS PALOS, Nº 39

41006-SEVILLA

TELF. 954643569

freyesl@freyesl.com

TUBERIAS Y ACCESORIOS PARA CONDUCTOS DE VENTILACIÓN

ACOPLE REJILLA LATERA, SUPERIOR, CIRCULAR

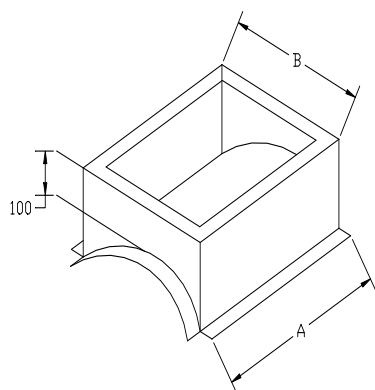
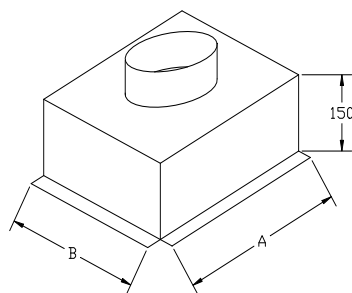
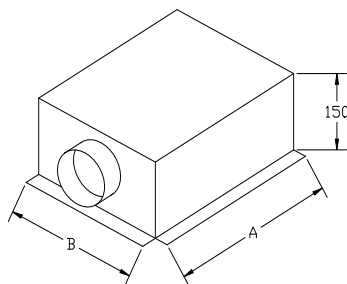

DIMENSIONES REJILLAS		
A*B	LATERAL SUPERIOR	CIRCULAR
200*150	30,20	25,40
250*150	30,20	25,40
300*150	30,20	25,40
350*150	33,62	26,53
400*150	33,62	27,66
450*150	38,18	28,79
500*150	38,18	28,79
200*200	32,48	27,95
250*200	32,48	27,95
300*200	32,48	27,95
350*200	37,32	29,18
400*200	37,32	30,43
450*200	43,30	31,61
500*200	43,30	31,61

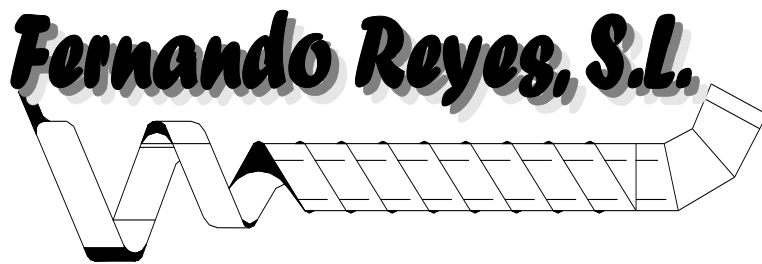

POLIGONO INDUSTRIAL NAVISA

C/ LOS PALOS, Nº 39

41006-SEVILLA

TELF. 954643569

freyesl@freyesl.com

TUBERIAS Y ACCESORIOS PARA CONDUCTOS DE VENTILACIÓN

TUBO LISO DE 1 m. DE CHAPA GALVANIZADA



D	0.6 mm. de esp.	0.8 mm. de esp.	1 mm. de esp.
	€/m	€/m	€/m
100	12,00		
125	12,64		
150	13,60	17,40	
175	15,63	18,90	22,14
200	17,40	20,26	23,87
250	20,88	24,90	28,94
300	22,80	27,47	32,87
350	27,70	33,75	
400	29,20	35,76	
450	32,18	39,00	
500	33,70	41,00	

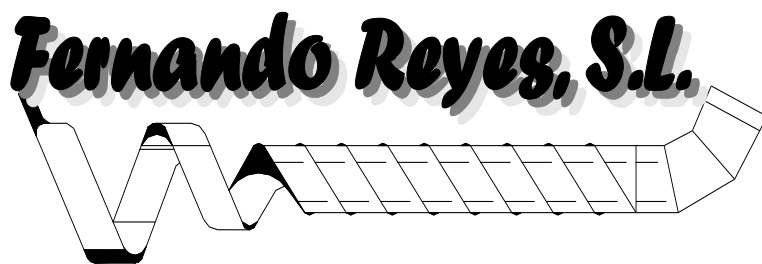

POLIGONO INDUSTRIAL NAVISA

C/ LOS PALOS, Nº 39

41006-SEVILLA

TELF. 954643569

freyesl@freyesl.com

TUBERIAS Y ACCESORIOS PARA CONDUCTOS DE VENTILACIÓN

ACERO INOXIDABLE 0.5 mm. MATE

TUBERIA LISA MACHO-HEMRADO

UNIONES LONGITUDINALES ELECTROSOLDADAS POR PUNTOS

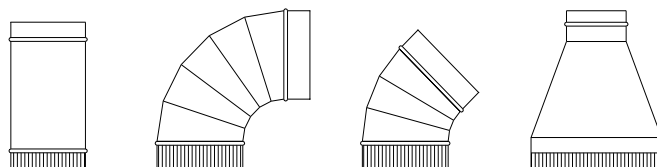

D	Tubos (1 m.)	Codos de 90°	Codos de 45°	Reducción
100	18,65	20,12	15,24	19,96
125	20,79	21,27	16,33	20,61
150	24,48	24,18	18,51	22,86
175	28,28	30,76	20,83	26,63
200	29,84	35,90	25,86	28,67
250	38,99	42,02	33,21	33,20
300	44,50	49,05	41,65	37,59
350	54,06	59,34	49,35	42,64
400	59,83	65,32	62,78	48,84

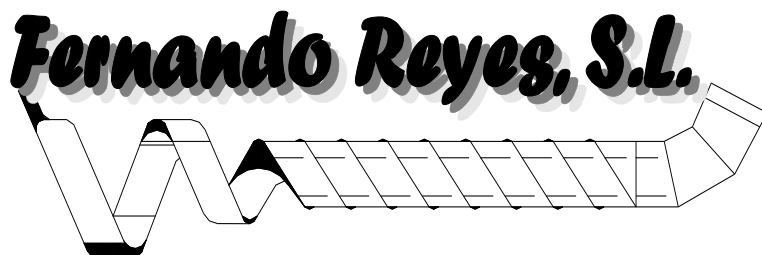

POLIGONO INDUSTRIAL NAVISA

C/ LOS PALOS, Nº 39

41006-SEVILLA

TELF. 954643569

freyesl@freyesl.com

TUBERIAS Y ACCESORIOS PARA CONDUCTOS DE VENTILACIÓN

ACERO INOXIDABLE 0.5 mm. MATE

TUBERIA LISA MACHO-HEMRADO

UNIONES LONGITUDINALES ELECTROSOLDADAS POR PUNTOS

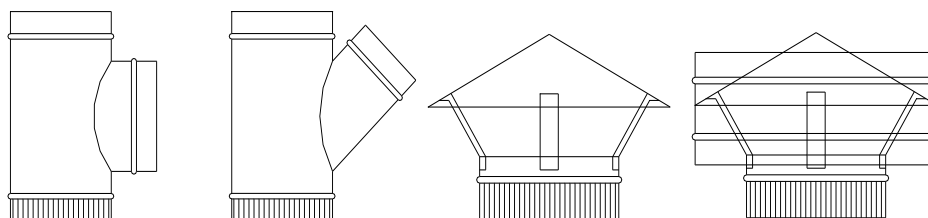

D	Te de 90°	Te de 45°	Caperuza Simple	Deflector
100	20,95	26,71	23,75	27,30
125	21,97	29,65	24,58	28,00
150	25,00	34,00	26,77	31,30
175	28,86	38,35	30,00	36,64
200	32,80	46,10	32,10	38,70
250	42,52	54,55	35,60	44,11
300	51,78	69,18	42,45	51,80
350	60,70	84,35	49,20	58,44
400	69,25	101,03	55,15	65,60

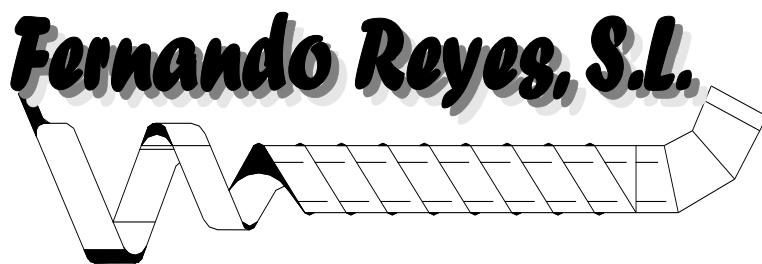

POLIGONO INDUSTRIAL NAVISA

C/ LOS PALOS, Nº 39

41006-SEVILLA

TELF. 954643569

freyesl@freyesl.com

TUBERIAS Y ACCESORIOS PARA CONDUCTOS DE VENTILACIÓN

ACERO INOXIDABLE 0.5 mm. MATE

TUBERIA LISA MACHO-HEMRADO

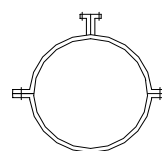
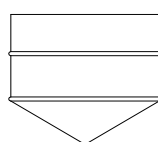
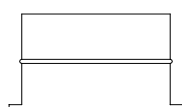

D	Tapa	Tapa Cónica	Soporte
100	9,65	12,13	7,80
125	11,24	14,14	7,80
150	12,96	16,31	8,42
175	14,40	18,10	9,14
200	15,46	19,43	10,18
250	16,24	20,41	11,53
300	17,58	22,10	15,04
350	20,21	25,40	15,67
400	22,81	28,70	16,70